



PEG Gastrostomy Tube Feeding Instructions

Bolus Feeding: Syringe

- Supplies:**
- 60 mL syringe
 - Feeding (liquid food)
 - Plain tap water for rinsing tube
 - Tubing
 - Tape for securing tube

After every medicine and after each feeding, flush the tube with 5 to 10 mL of water.

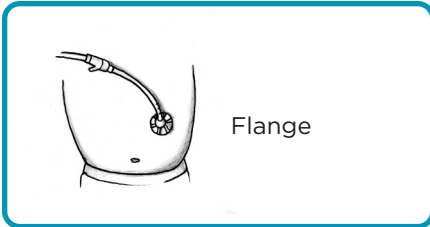

Flange

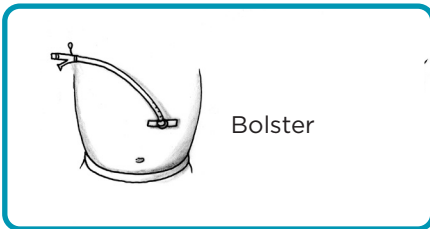

Bolster

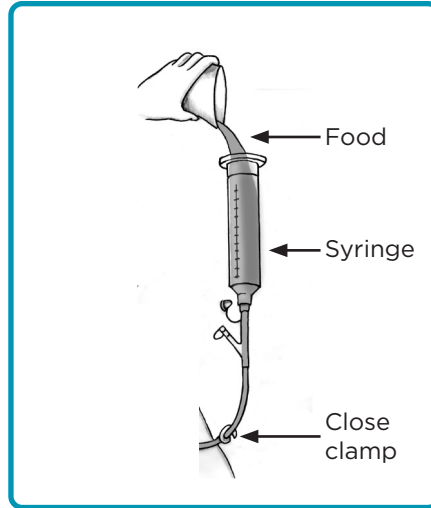

Step 1

Close clamp on PEG tube. Connect syringe to PEG tube and fill with liquid food.

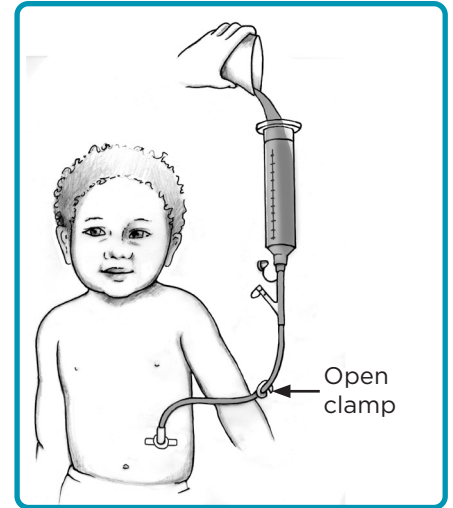

Step 2

Open clamp and start liquid feed.

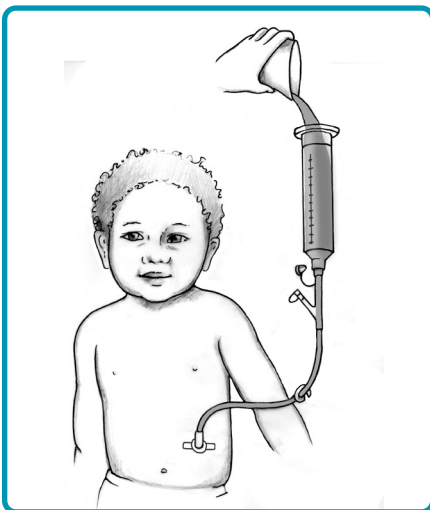

Step 3

Feeding drips in by gravity, usually over 10 to 20 minutes. Control the flow of feeding by the height of the syringe. The nurse will show you how to do this.

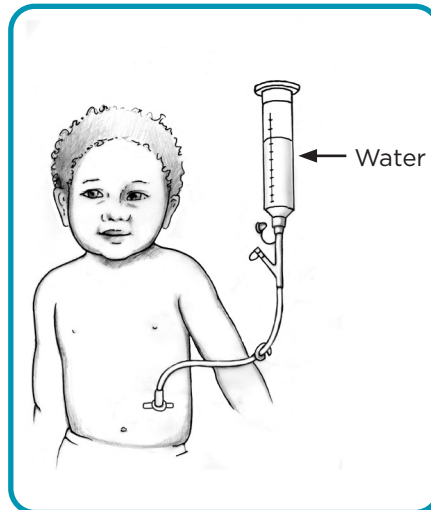

Step 4

When feeding is complete, flush tube with 5 to 10 mL water as instructed.

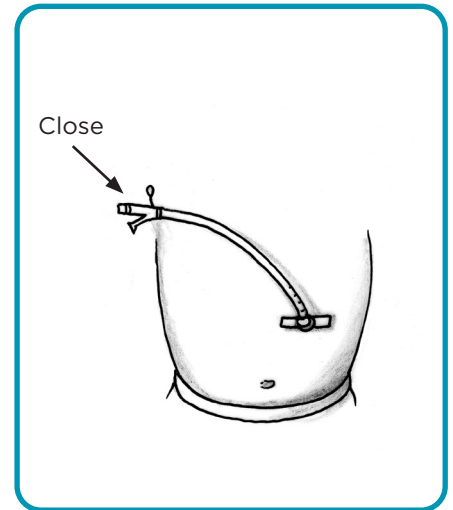

Step 5

Close clamp. Disconnect syringe and close feeding tube.

PEG Gastrostomy Tube Feeding Instructions

Bolus Feeding: Bag

- Supplies:**
- Feeding bag
 - Feeding (liquid food)
 - Plain tap water for rinsing tube
 - 20 mL syringe
 - Tubing
 - Tape for securing tube

After every medicine and after each feeding, flush the tube with 5 to 10 mL of water.

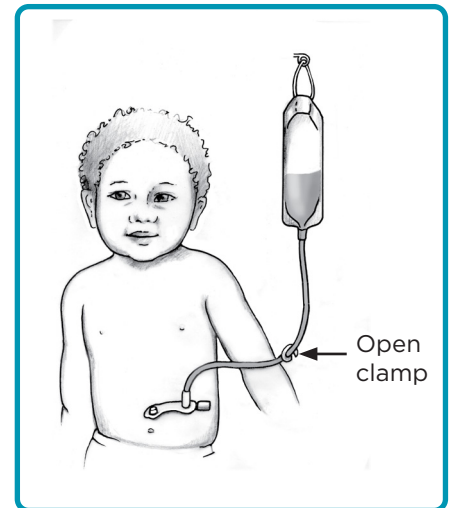
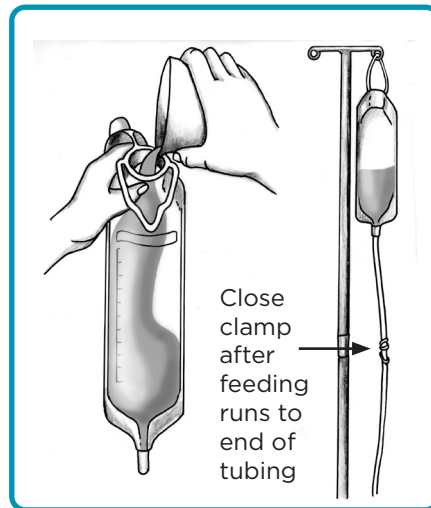
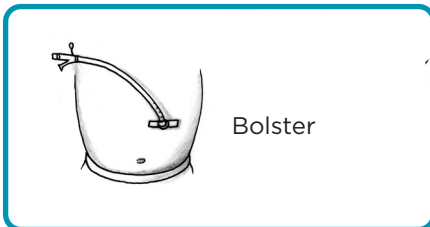
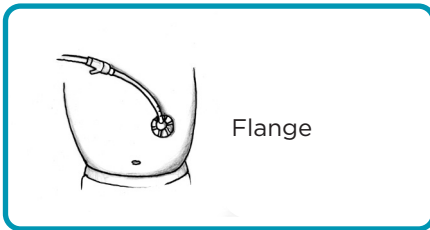

Step 1
Close clamp on tube. Connect bag and fill with liquid food.

Step 2
Connect tubing and bag to PEG. Open clamp and start feed.



Step 3
Feeding drips in by gravity, usually over 10 to 20 minutes. Control the flow of feeding by the height of the bag. The nurse will show you how to do this.

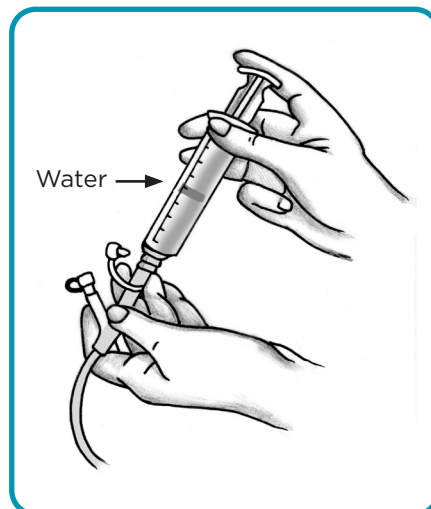

Step 4
When feeding is complete, flush tube with 5 to 10 mL water as instructed.

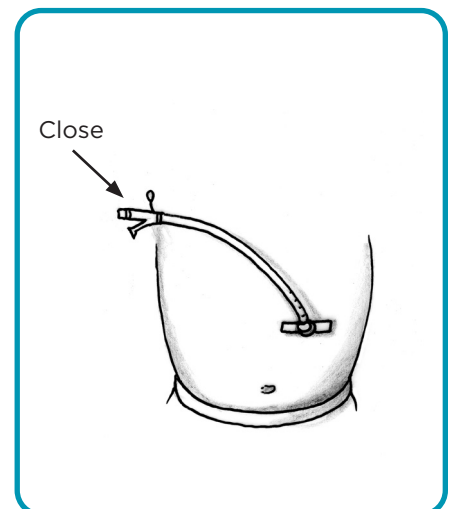

Step 5
Disconnect bag and close feeding tube.

PEG Gastrostomy Tube Feeding Instructions

Continuous Feeding with Pump

- Supplies:**
- Feeding bag
 - Feeding (liquid food)
 - Plain tap water for rinsing tube
 - 20 mL syringe
 - Tubing
 - Tape for securing tube

After every medicine and after each feeding, flush the tube with 5 to 10 mL of water.

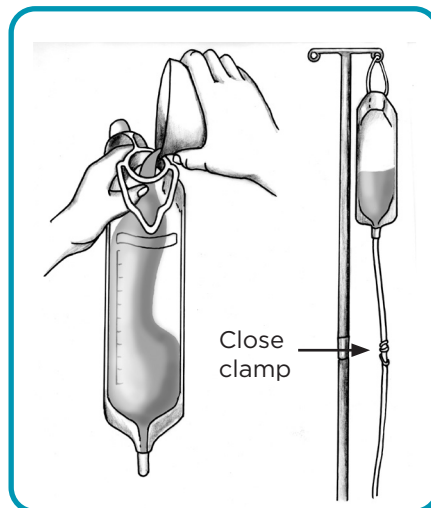
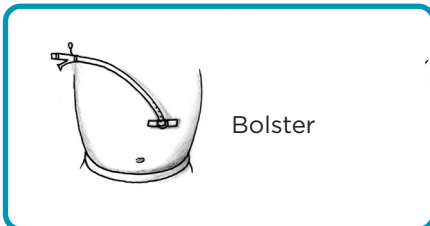
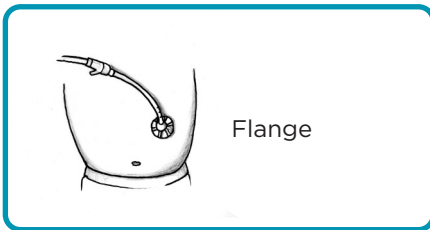

Step 1
Be sure clamp is closed. Fill bag and tubing with liquid food.

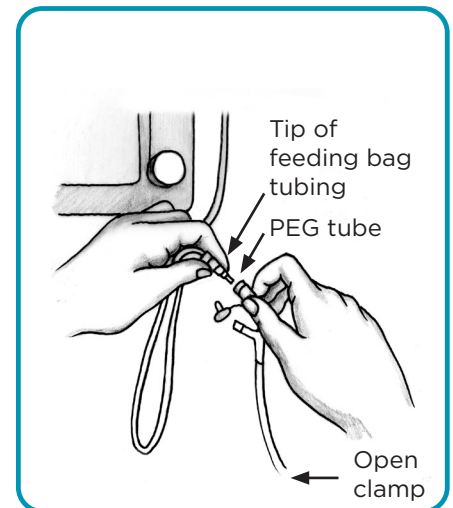

Step 2
Connect tubing and bag to PEG. Put on pump. Open clamp and start feed.

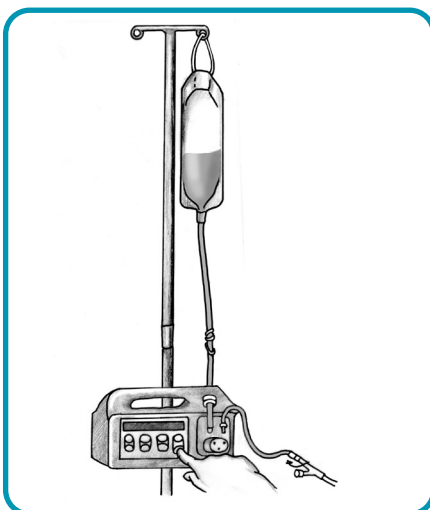

Step 3
The rate of feeding is regulated by the pump. The home care company providing supplies and the feeding pump will provide training materials for you. Your home pump may look very different than this one.

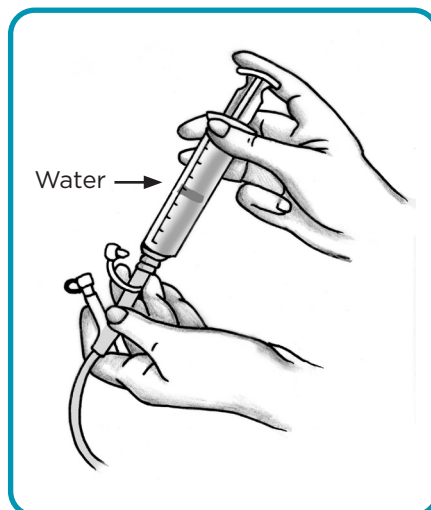

Step 4
When feeding is complete, flush tube with 5 to 10 mL water as instructed.

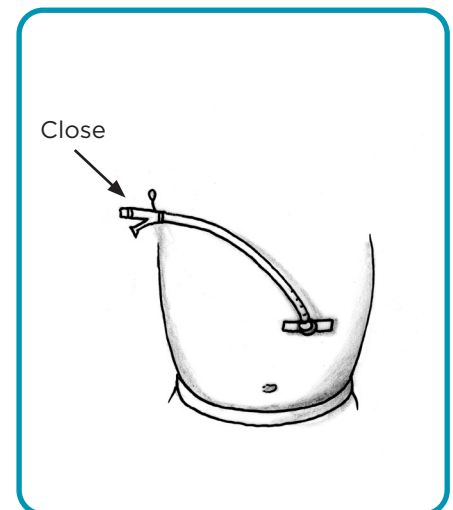

Step 5
Disconnect bag and close feeding tube.

PEG Gastrostomy Tube Feeding Instructions

Care of a PEG Tube

When to be concerned:

- Tube falls out.
- Tube is clogged (cannot flush tube).
- Tube is leaking a lot.
- Site around the tube is red, swollen or draining.
- Stomach is distended (appears larger or swollen) and firm, and your child is uncomfortable.

Who to call:

- General Surgery
206-987-2794
- Gastroenterology
206-987-2521
- Interventional Radiology
206-987-2133

After hours, call the hospital operator: 206-987-2000

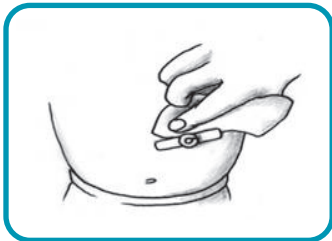

Cleanse

the site once a day with soap and water using a soft cloth. Wash around the tube and let the site air dry.

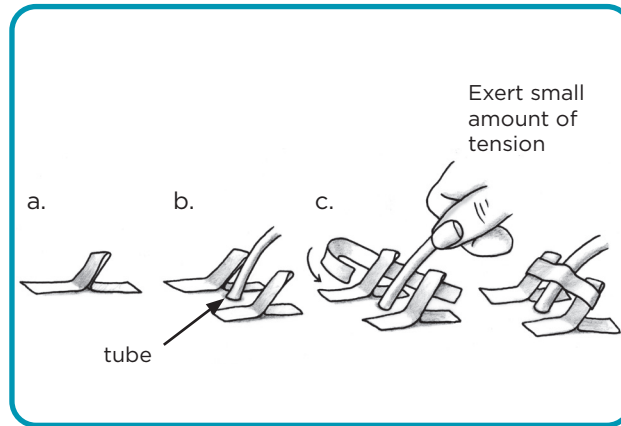

Securing tube: H-tape technique

While the tube site is healing, use tape to secure the PEG. This helps prevent your child from pulling out the tube.

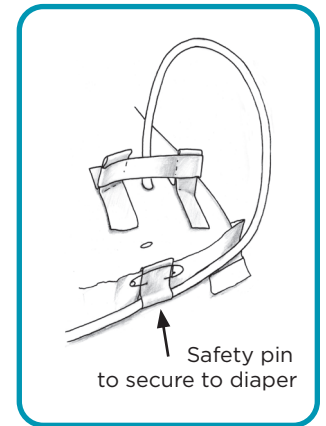

Tube Care Reminders

- If there is drainage around the tube, your child's provider may recommend using a zinc-based barrier cream such as diaper paste to protect skin.
- Your child's provider may recommend using a gauze or non-adhesive sponge dressing that will absorb any drainage and keep the skin dry.
- Your child may take a bath or shower 7 days after the tube is placed.
- "Tummy time" may occur again after the tube has been in place for 10 days.

A common concern with gastrostomy tubes is clogging with liquid food or medicines.

- The best prevention is to rinse the tube with 5 to 10 mL of water after each medicine and after each feeding.
- Do not mix medicines in the formula, because medicines and some foods can interact and form a clog in the tube.
- Medicines given through a GT must be finely crushed and mixed with water.
- Let your pharmacist know that medicines will be given through a GT, and that liquid forms are preferred.

Treatment if the GT becomes clogged

- Flush with 5 to 10 mL warm water and pressure.
- Call your healthcare provider if you cannot unblock the tube.

Seattle Children's offers interpreter services for Deaf, hard of hearing or non-English speaking patients, family members and legal representatives free of charge. Seattle Children's will make this information available in alternate formats upon request. Call the Family Resource Center at 206-987-2201.

This handout has been reviewed by clinical staff at Seattle Children's. However, your child's needs are unique. Before you act or rely upon this information, please talk with your child's healthcare provider.

© 2020 Seattle Children's, Seattle, Washington. All rights reserved.